

# PHILIPS

## Ledinaire batten

### BN021C

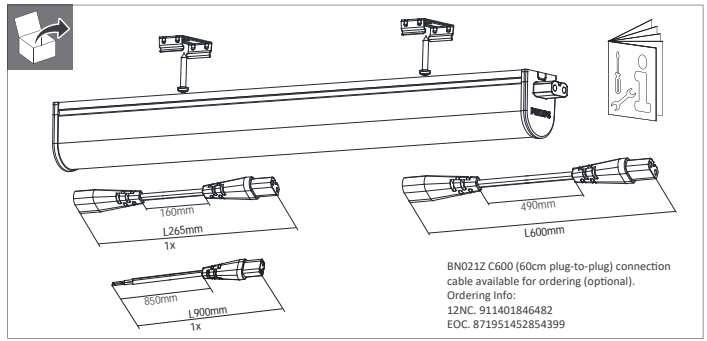

220V  
240V

50Hz  
60Hz



Max  
40°C  
Min  
-20°C

Ta  
25°C

IP20

L65 B50  
50k hrs



		System lumen (lm)	CCT (K)	Length(mm)	P(W)	
BN021C LED5S/840 L300	•	500	4000	326	5	0.06
BN021C LED5S/830 L300	•	480	3000			
BN021C LED10S/840 L600	•	1000	4000	586	10	0.09
BN021C LED10S/830 L600	•	940	3000			
BN021C LED15S/840 L900	•	1500	4000	886	15	0.13
BN021C LED14S/830 L900	•	1450	3000			
BN021C LED20S/840 L1200	•	2000	4000	1186	20	0.17
BN021C LED19S/830 L1200	•	1900	3000			
BN021C LED25S/840 L1500	•	2500	4000	1486	24	0.21
BN021C LED24S/830 L1500	•	2400	3000			

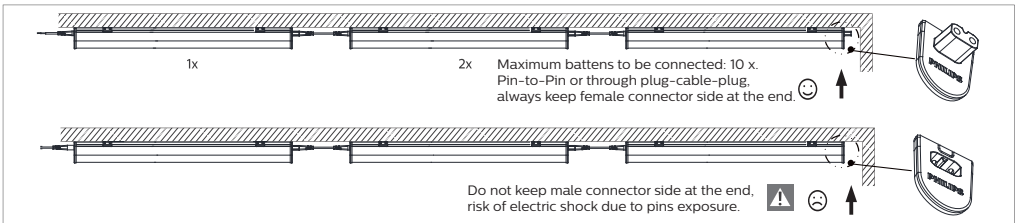
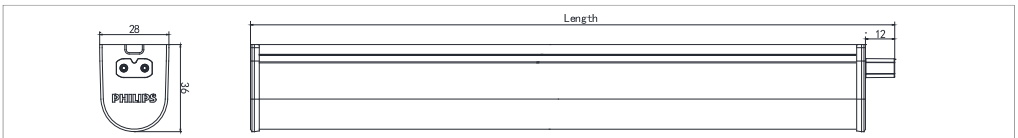

- The luminaire shall be installed by a qualified electrician and wired in accordance with the latest IEE electrical regulations or the national requirements.
- LED board & LED driver are not serviceable and not replaceable.
- The light source of this luminaire is not replaceable; when the light source reaches its end of life the whole luminaire shall be replaced.
- Luminaire must not be used or stored in corrosive environment where hazardous materials such as sulphur, chlorine, phthalates, etc. are present.
- If the external flexible cable or cord of this luminaire is damaged, it shall be replaced by a special cord or cord exclusively available from the manufacturer or his service agent.



ATTENTION  
OBSERVE PRECAUTIONS  
FOR HANDLING  
ELECTROSTATIC  
SENSITIVE  
DEVICES

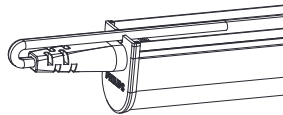
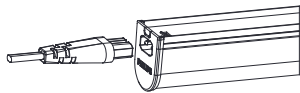
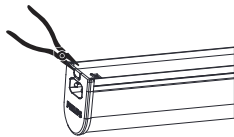

1

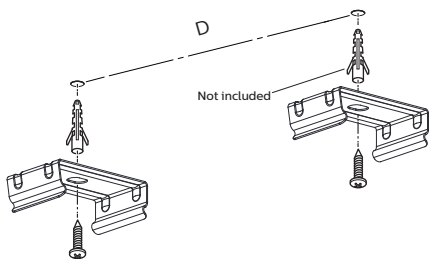

Type	L300	L600	L900	L1200	L1500
D/mm	200-250	350-450	500-650	700-850	850-1000

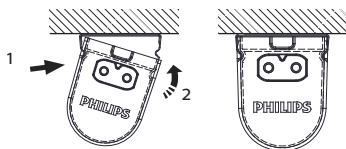
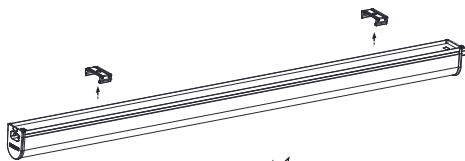

2

3

#### Inrush current

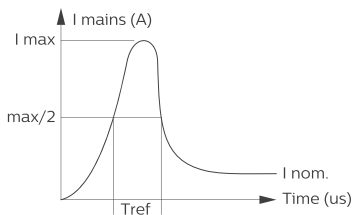

	LED5S	LED10S	LED15S	LED20S	LED25S
			LED14S	LED19S	LED24S
Electrical characteristics					
Imax (A)	8.7	9	11	14.3	16.8
Tref (µs)	1	1	1	1	1
MCB Luminaire Max					
B-10A	10	10	10	10	10
B-16A	10	10	10	10	10
C-10A	10	10	10	10	10
C-16A	10	10	10	10	10

4

© 03/2021 Signify Holding.

All rights reserved. This document contains information relating to the product portfolio of Signify which information may be subject to change. No representation or warranty as to the accuracy or completeness of the information included herein is given and any liability for any action in reliance thereon is disclaimed. The information presented in this document is not intended as any commercial offer and does not form part of any quotation or contract. Philips and the Philips Shield Emblem are registered trademarks of Koninklijke Philips N.V.. All other trademarks are owned by Signify Holding or their respective owners.

Signify Holding,  
The Netherlands